

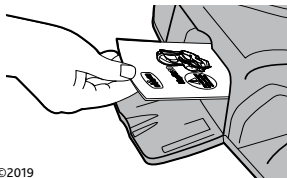

# KeyFit<sup>®</sup> 30

## Car Seat User Guide

For future use, STORE USER GUIDE  
in location on bottom of base.



**READ USER GUIDE  
before using this  
child restraint.**

If you have any problems with your Chicco Child Restraint,  
or any questions regarding installation or use, please call:

**Elfe Juvenile Products Customer Service**  
**1-800-667-8184**  
**or email us at [service@chicco.ca](mailto:service@chicco.ca)**

Please have Model and Serial Number available when you call.  
These are located on a label on the bottom of the Child Restraint.

For future reference, fill in the information below.

The information can be found on the label on the bottom of the Child Restraint.

**Model Number:** \_\_\_\_\_

**Serial Number:** \_\_\_\_\_

**Manufactured In:** \_\_\_\_\_

# TABLE OF CONTENTS

Registration	2
Child Guidelines	4
Safe Use Checklist	6
Important Warnings	8
Best Practices	14
Need Help?	15

## VEHICLE INFORMATION

Vehicle Seating Positions	16
Vehicle Seat Belts	18
What is UAS?	20

## CHILD RESTRAINT OVERVIEW

Child Restraint Components	22
Child Requirements	26

## BASE INSTALLATION

Install with Base Setup	28
Install Using UAS	30
Install Using LAP-SHOULDER BELT	36
Install Using LAP BELT ONLY	42
Install Carrier to Base	46

## WITHOUT BASE INSTALLATION

Install without Base Setup	50
Install Using LAP-SHOULDER BELT	52
Install Using LAP BELT ONLY	56

## SECURING YOUR CHILD

Adjusting Harness Height	60
Securing Child with Harness	64
Secure Child Checklist	72

## ADDITIONAL INFORMATION

Base Release Handle	74
UAS Storage	75
Newborn Positioner	76
Head Rest Insert	78
Handle Positions	79
Canopy	80
Installation on an Aircraft	81
Cleaning and Maintenance	82

## REGISTRATION

Please complete the Registration Card that came with your Child Restraint and mail it promptly.

Child Restraints could be recalled for safety reasons. You must register this restraint to be reached in a recall. Send your name, address, e-mail address if available, and the restraint's model number and manufacturing date to:

**Elfe Juvenile Products**  
**2520 Av Marie-Curie,**  
**Saint-Laurent (QC) H4S 1N1**  
or call 1-800-667-8184  
or register online at **[www.chicco.ca](http://www.chicco.ca)**

For recall information, call Transport Canada at  
1-800-333-0371 or go to [www.tc.gc.ca](http://www.tc.gc.ca)

# REGISTRATION

PAGE INTENTIONALLY LEFT BLANK

## CHILD GUIDELINES

This Child Restraint is designed for children ages Birth to at least 2 years old.

**ONLY** use this Child Restraint if the child meets **BOTH** of the following Weight and Height requirements:

- **Weight is between 1.8 and 13.6 kg (4 and 30 lbs).**
- **Height is 76 cm (30 inches) or less and child's head is no less than 25 mm (1 inch) below the top of the head rest.**

The Newborn Positioner is only for infants who weigh between 1.8 and 5 kg (4 and 11 lbs). See Newborn Positioner on page 76.

**⚠** For premature infants, you must consult the infant's doctor before using this Child Restraint. A premature infant may have difficulty breathing or have other medical problems when placed in a seated position.

## CHILD GUIDELINES

**⚠ WARNING!** Use of this Child Restraint is **ONLY** for children who meet **ALL** of the requirements shown here. If the child is not within these requirements, select a different car seat (such as a convertible car seat).



- Chicco recommends all children ride **REAR-FACING** until age 2 or they reach the weight/height limits of this seat.
- **NEVER** turn this Child Restraint **FORWARD-FACING**.

## SAFE USE CHECKLIST

**⚠️ YOUR CHILD'S SAFETY DEPENDS ON YOU!** You **MUST** follow the detailed instructions in this User Guide to ensure the steps below are performed correctly!

- Make sure your child meets the age, weight, and height requirements:**  
Refer to the "Child Guidelines" section on page 4.
  
- If using Base, make sure Carrier is securely attached to Base:**  
Refer to the "Install Carrier to Base" section on page 46.
  
- Select a safe seating location in your car:**  
Refer to the "Vehicle Seating Positions" section on page 16 and 17.
  
- Install Base or Carrier Rear-Facing ONLY:**  
Refer to the "Child Guidelines" section on page 4.





## SAFE USE CHECKLIST

- Ensure that the Child Restraint is properly leveled when installed.**
  
- Check Child Restraint for a snug fit in your car:**  
While holding Child Restraint near belt path used, pull side to side and forward. Belt should remain tight and Child Restraint should not move more than 1" (25 mm) from vehicle seat back or side-to-side.
  
- Secure your child:**  
Refer to the "Securing Child with Harness" section on page 64.

## IMPORTANT WARNINGS



**FAILURE TO FOLLOW THESE INSTRUCTIONS AND THE PRODUCT LABELS CAN RESULT IN SERIOUS INJURY OR DEATH TO YOUR CHILD.**

### **Take Time to Read This User Guide**

- Carefully read and understand all instructions and warnings in this User Guide. Your child's safety depends on you knowing how to setup, install and use this Child Restraint properly.
- Before installing this Child Restraint in a vehicle, be sure to also check the vehicle owner's manual for information on proper installation.
- **NEVER** allow others to use this Child Restraint until they have read and understood all instructions in this User Guide.
- For future reference, keep this User Guide in storage door at rear of Base.

### **Make Sure Child Fits This Child Restraint**

- Use only with children who weigh between 1.8 kg to 13.6 kg (4 and 30 lbs) and whose height is 76 cm (30 inches) or less.
- **Do Not** use this child restraint if top of child's head is within 1 inch of the top of the headrest.
- Only use the NEWBORN POSITIONER provided for infants who weigh between 1.8 and 5 kg (4 and 11 lbs).

## IMPORTANT WARNINGS

### **WARNING**

**DEATH or SERIOUS INJURY CAN OCCUR**

### **Secure Child Properly**

- Snugly adjust the belts provided with this child restraint around your child. A loose harness could cause the child to be ejected in a sharp turn, sudden stop or crash, resulting in serious injury or death.

A snug strap should not allow any slack. It lies in a relatively straight line without sagging. It does not press on the child's flesh or push the child's body into an unnatural position.

- **NEVER** use clothing or blankets that interfere with fastening or tightening the harness. An unsecured child could be ejected in a sharp turn, sudden stop or crash!

To keep child warm, place a blanket over child and restraint **AFTER** you have properly secured child in harness.

- **ALWAYS** check to make sure buckle is securely latched. If buckle separates, child could be killed or seriously injured.
- **NEVER** leave child unattended. Do not allow children to play in or around the Child Restraint.
- **ALWAYS** keep child properly secured in harness whenever child is in carrier.

## IMPORTANT WARNINGS

### **! WARNING**

DEATH or SERIOUS INJURY CAN OCCUR

### Install Child Restraint Correctly

- **NEVER PLACE THIS CHILD RESTRAINT IN VEHICLE SEATING LOCATION WITH A FRONTAL AIR BAG, UNLESS THE AIR BAG CAN BE TURNED OFF.** If the airbag inflates, it can cause serious injury or death to your child. For vehicles with side air bags, refer to your vehicle owners manual for information on your child restraint installation.
- **ALWAYS** install this Child Restraint in a back seat if possible.



According to accident statistics, children are safer when properly restrained in the rear seating positions rather than in the front seat.

- **NEVER** install in a rear facing, side facing or on the back of a folded down vehicle seat.
- **ALWAYS** secure this Child Restraint with the vehicle's child restraint anchorage system (UAS) if available OR with a vehicle seat belt. **Never use both at the same time.**
- **ALWAYS** install rear-facing when using this Child Restraint in a vehicle. Your child could be killed or seriously injured if you install this restraint forward-facing.

## IMPORTANT WARNINGS

### **WARNING**

**DEATH or SERIOUS INJURY CAN OCCUR**

### **Install Child Restraint Correctly**

- **BEFORE** each use, **ALWAYS** check to make sure restraint is tightly secured in the vehicle seat.
- **NEVER** use Child Restraint in a vehicle seating position where it cannot be secured tightly. A loosely installed child restraint will not protect your child in a crash.
- **Never leave carrier or base unsecured in your vehicle even when it is unoccupied.** It could injure other occupants in a sharp turn, sudden stop or crash.
- **DO NOT** install this child restraint using an inflatable seat belt. The interaction of the inflatable portion of the vehicle's belt with this child restraint **can result in serious injury or death.** Install using UAS instead, or move the car seat to a position with a suitable seat belt type.
- To **prevent ejection or breathing difficulties, proper recline is required.** When installing the Child Restraint, check the bubble level on the base. Refer to pages 26-27 to make sure your child meets the requirements.
- Make sure nothing interferes with carrier attachment to base. **ALWAYS** check attachment.
- **ONLY** use Chicco KeyFit/KeyFit 30 infant carriers with KeyFit/KeyFit 30 bases.
- **DO NOT** use Chicco KeyFit/KeyFit 30 infant carriers with Chicco Fit 2 bases.

## IMPORTANT WARNINGS



### Ensure Child's Safety When Using Child Restraint

- **NEVER** leave child unattended.
- **SUFFOCATION HAZARD:** Infant carrier can roll over on soft surfaces and suffocate child. **NEVER** place carrier on beds, sofas or other soft surfaces.
- **STRANGULATION HAZARD:** Children have **STRANGLED** in loose or partially buckled harness straps. Fully restrain the child even when carrier is used outside the vehicle.
- **Fall Hazard:** Child's activity can move carrier. **NEVER** place carrier on counter tops, tables, or any other elevated surface.
- Do not use the infant carrier if it is damaged or broken.
- **BE SURE** handle is locked in the "carry position" before lifting carrier by handle. An unlocked handle could move unexpectedly, causing injury to child.
- **NEVER** place carrier in top of shopping cart. Carrier will not be secure and could fall causing injury to child.
- **ALWAYS** check buckle and other parts for hot surfaces. A hot surface could burn child! Cover unoccupied carrier with blanket when leaving in a vehicle exposed to sunlight or high temperatures.

## IMPORTANT WARNINGS



### Check Condition of Restraint

- **DO NOT** use if the Harness or UAS straps are cut, frayed or damaged.
- **DO NOT use this Child Restraint if it is more than 6 years old** from manufacture date or date of purchase (proof of purchase required). The manufacture date can be found in 2 locations, on the underside of carrier and in the recess of base.
- **DO NOT use any accessories, pads or products not included with this Child Restraint, unless approved by Chicco.** Doing so will void the warranty of this Child Restraint.
- **You MUST** replace this Child Restraint if it has been involved in a crash, even if you cannot see visible damage. A damaged Child Restraint may not protect your child in a future crash.
- **Do not modify your Child Restraint.**
- For proper removal and installation of the harness straps contact Chicco for additional instructions.
- **Do not use Child Restraint if any component is damaged, broken, or missing parts.**  
Call 1-800-667-8184 to find out if the damaged part or parts can be replaced.

## BEST PRACTICES

- Ensure all vehicle occupants are properly restrained before traveling. Unrestrained occupants can be thrown around and may be seriously injured or seriously injure other occupants in a sharp turn, sudden stop or crash.
- Do not leave loose objects, such as books, bags, etc., in the back of the vehicle. In the event of a sharp turn, sudden stop, or crash, loose objects can be thrown around and possibly cause serious injury to vehicle occupants.
- Cover the Child Restraint when the vehicle is parked in sunlight. Parts of a Child Restraint can become very hot if left in the sun. Contact with these parts can burn a child's skin. Always check the surface of any metal or plastic parts before putting your child in the Child Restraint.
- To avoid strangulation, Do not allow children to play with vehicle seat belts. If possible, move unused belts out of reach.
- Do not use anything to raise the Child Restraint off the vehicle seat. In a sharp turn, sudden stop, or crash, the Child Restraint could slide and potentially cause serious injury.
- Never use a second-hand Child Restraint with an unknown history.
- Never use any accessories that are not included with this child restraint, unless specifically approved by Chicco. For more information, go to [www.chicco.ca](http://www.chicco.ca).



### **Need Help Securing Your Child Restraint?**

The following sources are available to help ensure your Child Restraint is properly installed:

- Contact us by visiting our website at [www.chicco.ca](http://www.chicco.ca) or calling our Customer Service at 1-800-667-8184. Please have Model and Serial Number available when you call. These are located on a label on the bottom of the Child Restraint.
- Refer to your vehicle manual for Child Restraint installation tips.

## VEHICLE SEATING POSITIONS



**⚠ WARNING! NEVER PLACE THIS CHILD RESTRAINT IN A VEHICLE SEATING LOCATION WITH A FRONTAL AIR BAG, UNLESS THE AIR BAG CAN BE TURNED OFF.**

The back seat is the safest place for children 12 and under. See your vehicle owner's manual for Child Restraint installation and instructions.

This infant restraint system can only be used in the following types of vehicles: Multi Purpose Passenger Vehicle, Passenger Car and Trucks. This infant restraint system can be securely installed in most vehicles using the vehicle seat belts or UAS. BUT, there are some vehicle belts and installation positions that are UNSAFE for use with this infant restraint system.

## VEHICLE SEATING POSITIONS

Some vehicles have no seating positions which are compatible with this Child Restraint. If in doubt, contact the vehicle manufacturer for assistance. Only forward-facing vehicle seats can be used with this Child Restraint.



Make sure no more than 4 inches of the Child Restraint base is past the edge of the vehicle seat.

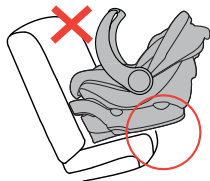

Do not use on a folded down vehicle seat back.



## VEHICLE SEAT BELTS

*The information in this section only applies to installation with vehicle seat belts.*

### **For simplest installation use UAS**

Vehicle seat belts differ from vehicle to vehicle. Refer to your vehicle owner's manual for specific information about seat belts and their use with Child Restraints.

### **Shoulder belt with switchable retractor:**

Putting the shoulder belt in the locked/switched mode as the last step is optional. The shoulder belt Lock-Off replaces the need for the locked/switched mode. Using the locked/switched mode may cause Child Restraint to tilt.

## VEHICLE SEAT BELTS

The following types of vehicle belts **MUST NOT** be used to install this Child Restraint. If any of the belt types listed below are in the chosen seating position, choose another vehicle seating position or use UAS if available.

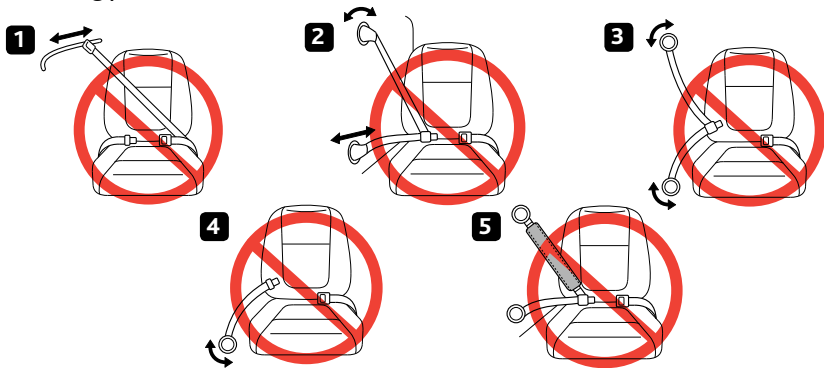

1. Motorized (automatic) vehicle belts.
2. Door mounted vehicle belts.
3. Lap-shoulder Belts with 2 retractors (unless Lap Belt has a "Lock Mode").
4. Non-Locking (ELR) Lap Belts.
5. Inflatable seat belts.

## WHAT IS UAS

**⚠ WARNING:** This Child Restraint is designed to be used with lower UAS anchors at the standard spacing (11 inches) **ONLY!** Refer to vehicle owner's manual for information about UAS and Child Restraint installation positions.

### **UAS** = **U**niversal **A**nchorage **S**ystem

Canadian Motor Vehicle Safety Standards have defined a system for installing Child Restraints in vehicles called lower Universal Anchorage System (UAS). **UAS may ONLY be used IN PLACE OF vehicle belt if the vehicle is equipped with UAS anchor points. DO NOT use both the seat belt and UAS at the same time. Please refer to the vehicle owner's manual for designated UAS locations in vehicles.**

**UAS** in the vehicle consists of two lower anchor points. Some vehicles owner's manual use the term "**ISOFIX**". **UAS** can also be used in vehicle seating positions equipped with **ISOFIX**.

If the vehicle is equipped with **UAS**, the vehicle lower anchor points may be visible at the seat crease. If not visible, the seating position may be marked with a symbol (fig. a) or a colored dot.

# WHAT IS UAS

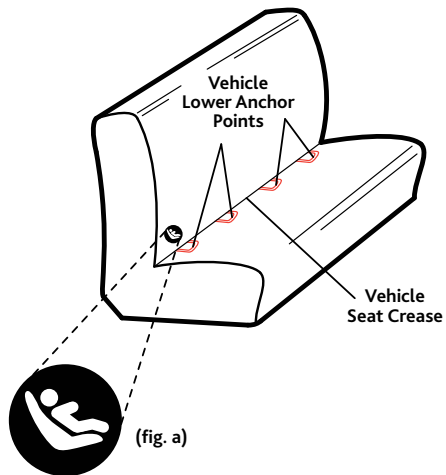

## CARRIER COMPONENTS

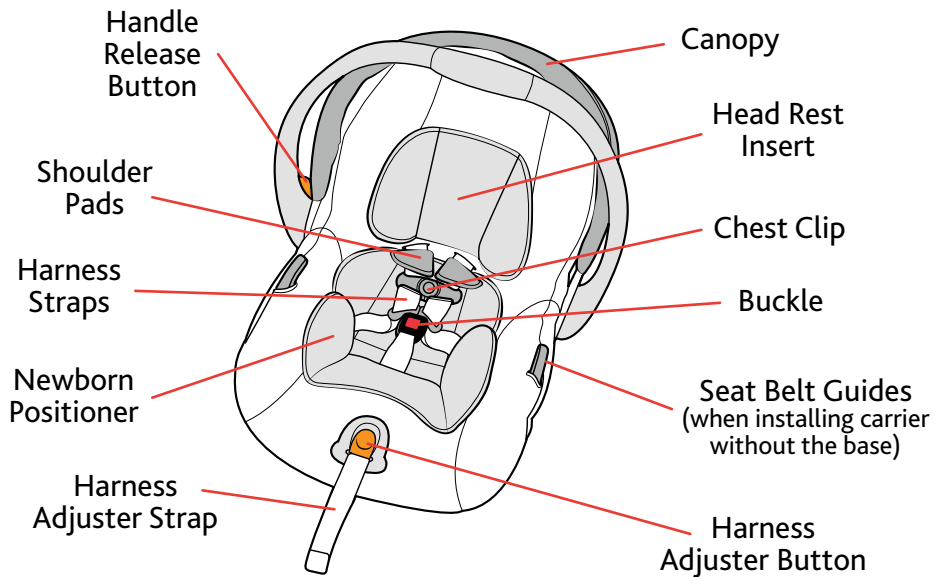



## CARRIER COMPONENTS

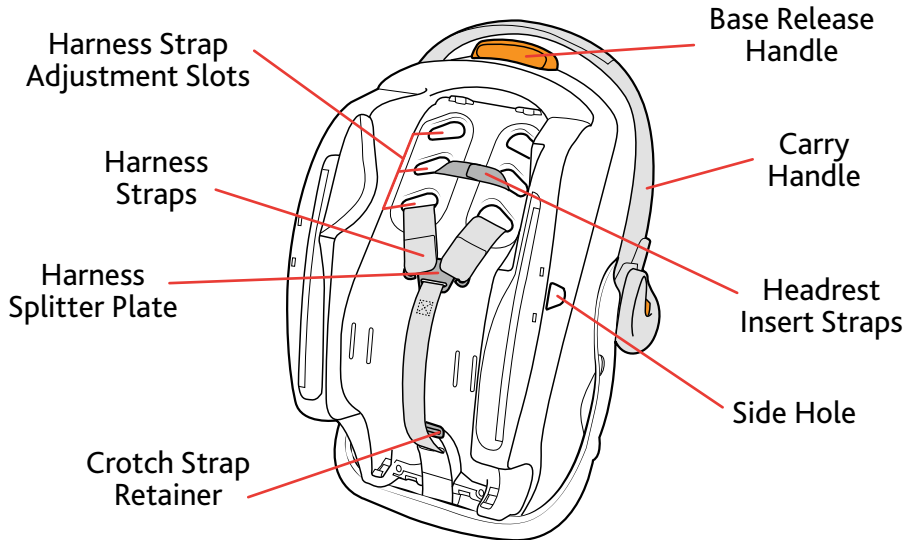

## BASE AND UAS COMPONENTS

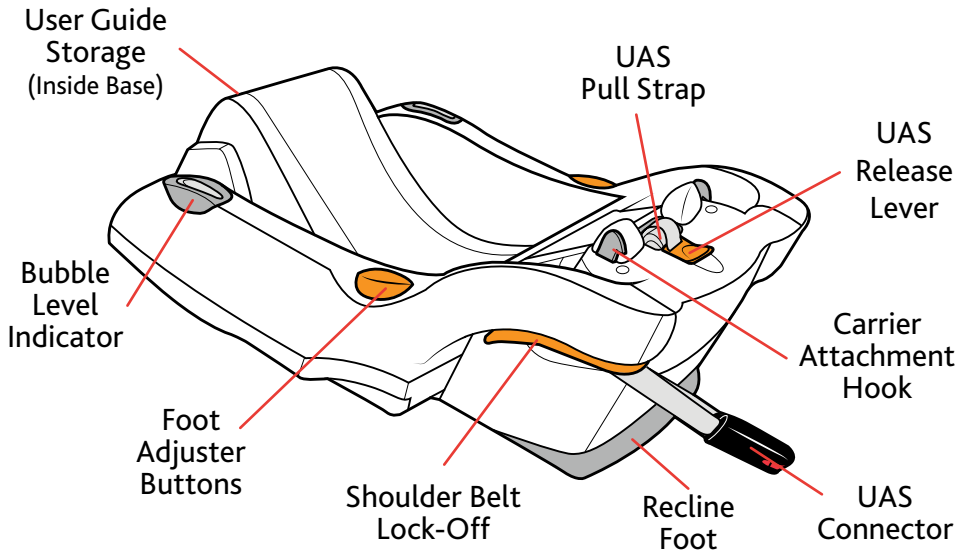

## BASE AND LATCH COMPONENTS

PAGE INTENTIONALLY LEFT BLANK

## CHILD REQUIREMENTS

### WEIGHT REQUIREMENTS:

**1.8 – 13.6 kg (4 – 30 lbs)**

Use with children:

- Who weigh between 1.8 –13.6 kg (4 and 30 lbs).
- And height is less than 76 cm (30 inches).
- And top of head is at least 25 mm (1 inch) below top of seat back.
- When Harness Straps can be positioned at or just below the child's shoulders\*.

See Adjusting Harness Height on page 60.



## CHILD REQUIREMENTS

⚠ For premature infants, you must consult the infant's doctor before using this Child Restraint. A premature infant may have difficulty breathing or have other medical problems when placed in a seated position.

### **Install Child Restraint:**

- *Base installation continued on page 28.*
- *Without Base Installation continued on page 50.*

## INSTALL WITH BASE SETUP

⚠ Infants may have difficulty breathing when in a sitting position. Make sure the seat is reclined properly so that your child's head does not fall forward. **Failure to properly recline the Child Restraint could increase the child's risk of serious injury or death.**

1



See page 16 for “Vehicle Seating Positions” before installing. Make sure the vehicle is on a level surface. Place Base on selected vehicle seat. Make sure it is not blocking the vehicle seat belt buckle.

2

Locate the Bubble Level Indicator and adjust the Recline Foot by pushing in on both Foot Adjuster buttons and lifting or lowering the base until the Bubble falls between the arrows on the Bubble Level Indicator **(2b)**.

**Installation Options:**

- *UAS installation continued on page 30.*
- *Lap-Shoulder Belt installation continued on page 36.*
- *Lap Belt Only installation continued on page 42.*

## INSTALL WITH BASE SETUP

2b

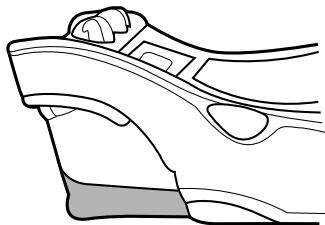
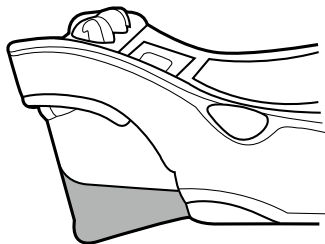
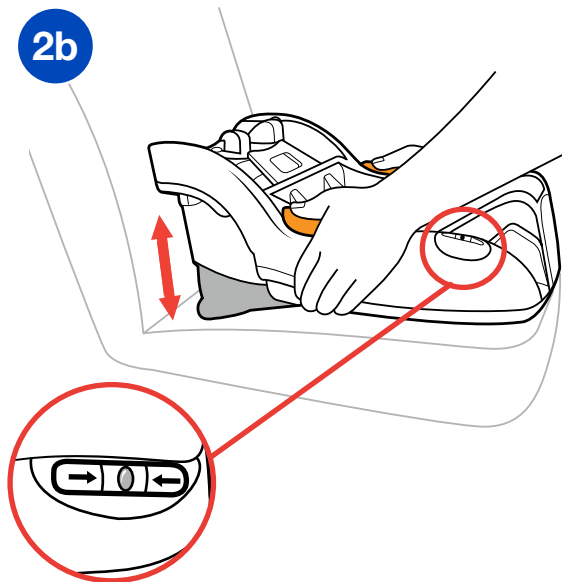

## INSTALL USING UAS

⚠ Store UAS Connectors properly in the compartments when not using for installation - See page 75.

⚠ When installing with UAS, the unused seat belt should not be buckled behind the Child Restraint System as this will engage the inflatable portion of the belt.

- 1 Pull up on the UAS Release Lever and loosen UAS straps to their full length.
- 2 Locate the UAS Connector storage compartments. Remove both UAS Connectors.



## INSTALL USING UAS

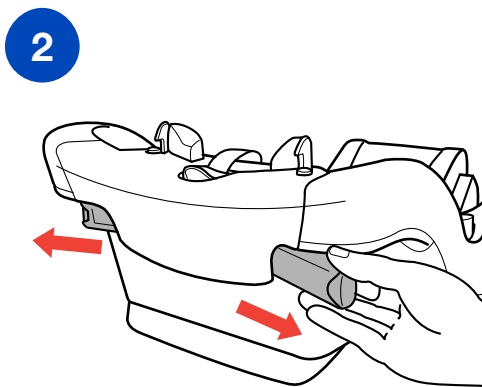
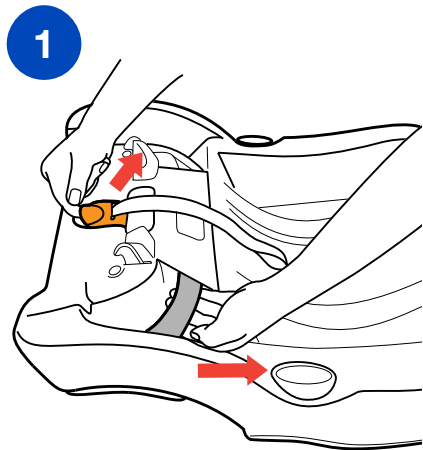

## INSTALL USING UAS

- 3 Locate the UAS anchor bars in your vehicle. Attach both UAS Connectors to the vehicle UAS anchor bars.
- 4 Tighten UAS straps by pulling up on UAS Pull Strap while pressing Base firmly into vehicle seat.

## INSTALL USING UAS

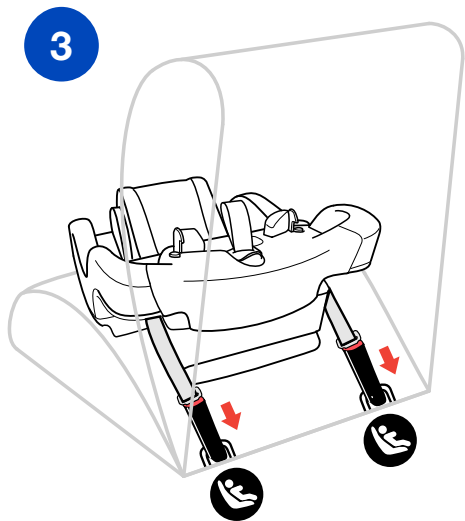

## INSTALL USING UAS

- 5 Roll UAS Pull Strap and store in Pull Strap Storage Slot, as shown.

### CHECK YOUR WORK

- ✓ Hold Base at each side and pull side to side and forward. Base should not move more than 25 mm (1 inch) from vehicle seat back or side-to-side.
- ✓ Check installation before every use!
- ✓ Make sure bubble falls between the arrows on the bubble level indicator.

### **Install Child Restraint:**

- *Installation continued on page 46.*

## INSTALL USING UAS

5

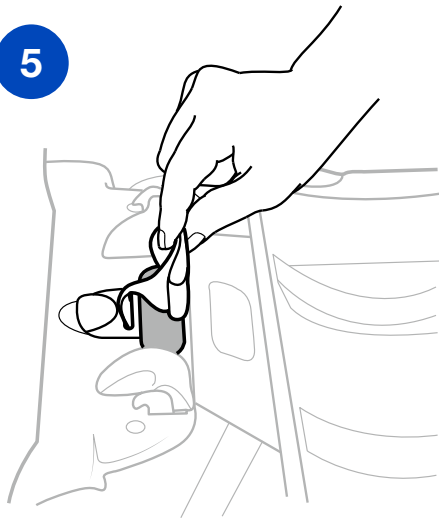

## INSTALL USING LAP-SHOULDER BELT

- 1 Thread vehicle seat belt up through the belt path on the side of the Base.
- 2 Pull vehicle seat belt down through the vehicle seat belt path on opposite side of the Base. Buckle the vehicle seat belt.

## INSTALL USING LAP-SHOULDER BELT

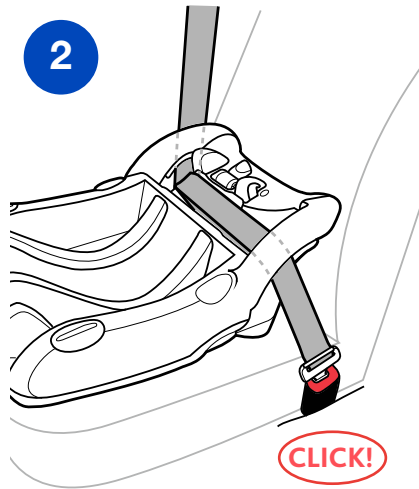
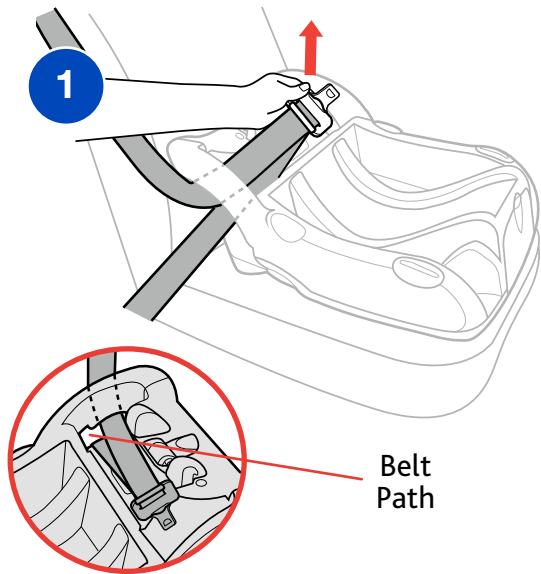

## INSTALL USING LAP-SHOULDER BELT

- 3 While pushing down on the Base, pull up on the vehicle shoulder belt to remove all slack from the vehicle lap belt.



## INSTALL USING LAP-SHOULDER BELT

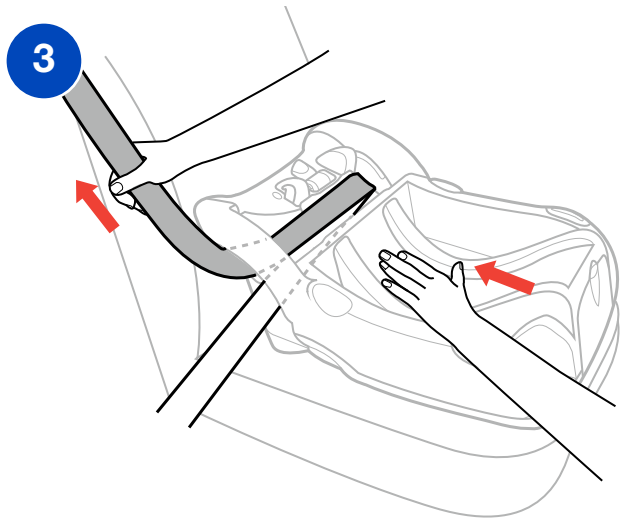

## INSTALL USING LAP-SHOULDER BELT

- 4 While holding the shoulder belt tight, slide the shoulder belt strap firmly into Shoulder Belt Lock-Off. Always use the Lock-Off on the opposite side of where the vehicle seat belt is buckled.

⚠ Do **NOT** pull on shoulder belt after it is positioned in Lock-Off. This could damage the Lock-Off and/or the vehicle belt

### CHECK YOUR WORK

- ✓ Hold Base at each side and pull side to side and forward. Base should not move more than 25 mm (1 inch) from vehicle seat back or side-to-side.
- ✓ Check installation before every use!
- ✓ Make sure bubble falls between the arrows on the bubble level indicator.

### Install Child Restraint:

- *Installation continued on page 46.*

## INSTALL USING LAP-SHOULDER BELT

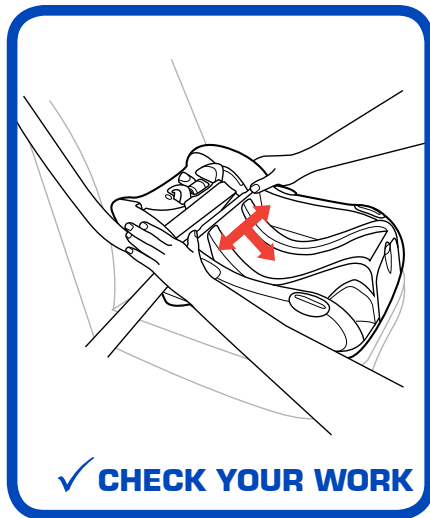
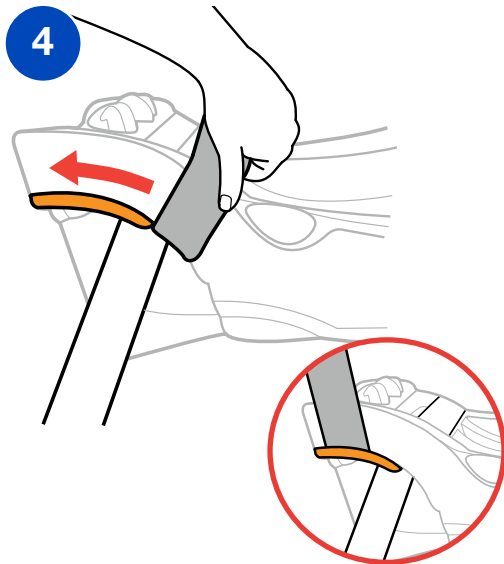

## INSTALL USING LAP BELT ONLY

- 1 Thread vehicle seat belt up through the belt path on the side of the Base.
- 2 Pull vehicle seat belt down through the vehicle seat belt path on opposite side of the Base. Buckle the vehicle seat belt.

# INSTALL USING LAP BELT ONLY

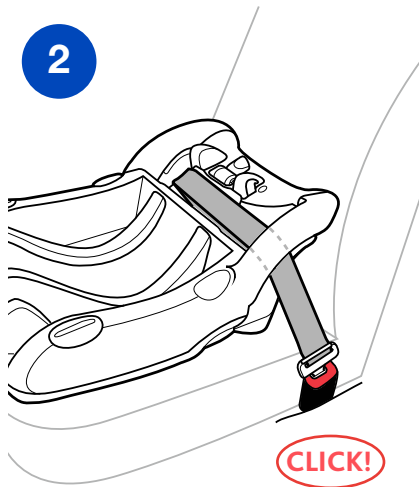
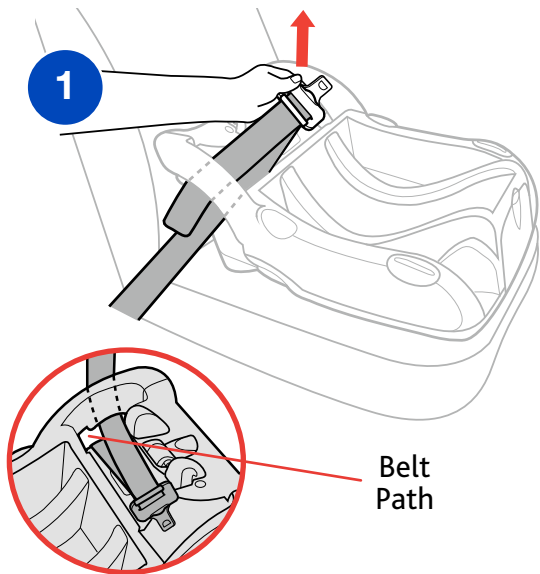

## INSTALL USING LAP BELT ONLY

- 3 While pushing down on the Base, pull up on the loose end of the vehicle lap belt to remove all slack.

### CHECK YOUR WORK

- ✓ Hold Base at each side and pull side to side and forward. Base should not move more than 25 mm (1 inch) from vehicle seat back or side-to-side.
- ✓ Check installation before every use!
- ✓ Make sure bubble falls between the arrows on the bubble level indicator.

### **Install Child Restraint:**

- *Installation continued on page 46.*

## INSTALL USING LAP BELT ONLY

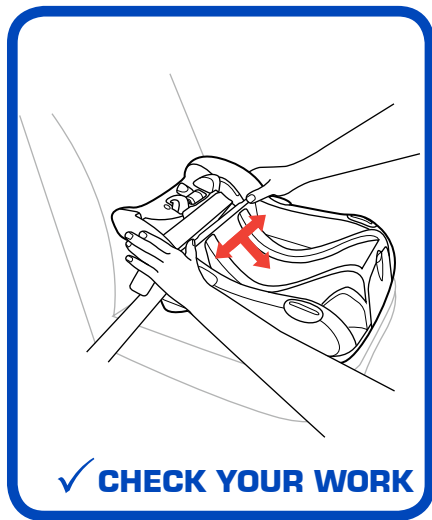
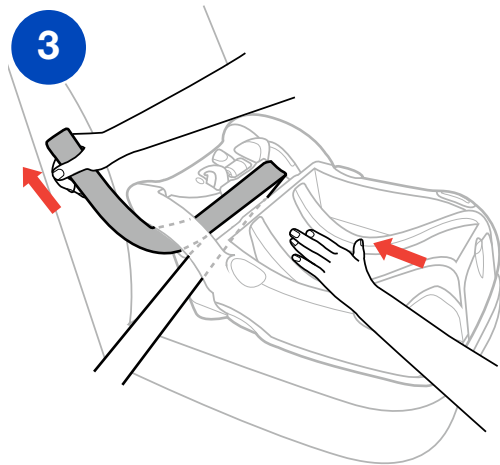

## INSTALL CARRIER TO BASE

- 1 Insert the Carrier into the Base.
- 2 Push down on the Carrier to make sure it locks onto the Carrier Attachment Hooks on the Base.



## INSTALL CARRIER TO BASE

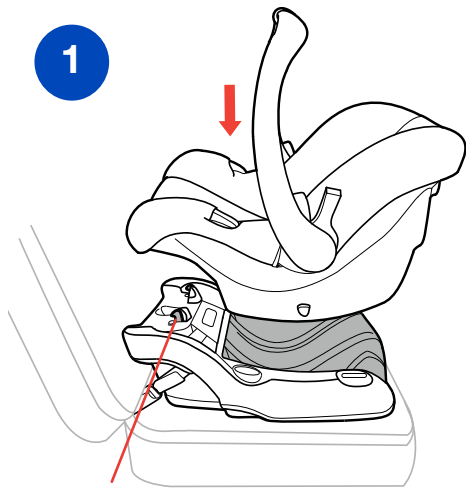

Carrier  
Attachment  
Hook



## INSTALL CARRIER TO BASE

- 3** Check to make sure the Carrier is securely attached to the Base.

- ⚠ **ALWAYS** lift up on Carrier to verify it is properly attached to the Base.
- ⚠ **ALWAYS** place handle in LOCKED "CARRY" position when using infant restraint system in vehicle.

### CHECK YOUR WORK

- ✓ Hold Base at each side and pull side to side and forward. Child Restraint should not move more than 25 mm (1 inch) from vehicle seat back or side-to-side.
- ✓ Make sure Child Restraint is level by confirming that the bubble on the level indicator is between the level lines. Make sure infant's head does not fall forward. If necessary, re-adjust recline and repeat installation steps to make sure Child Restraint is installed properly.
- ✓ Check installation before every use!

## INSTALL CARRIER TO BASE

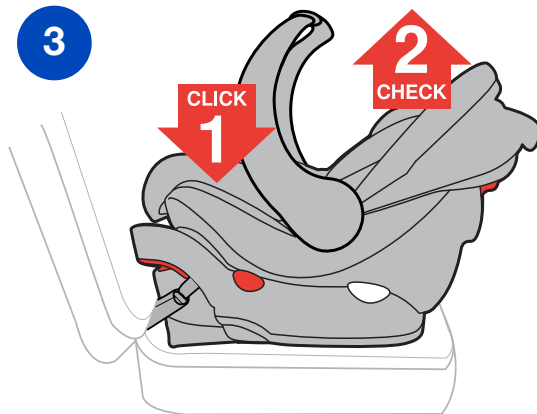

**⚠ ALWAYS** place handle in LOCKED "CARRY" position when using infant restraint system in vehicle.

INSTALL **WITHOUT** BASE SETUP

⚠️ Infants may have difficulty breathing when in a sitting position. Make sure the seat is reclined properly so that your child's head does not fall forward. **Failure to properly recline the Child Restraint could increase the child's risk of serious injury or death.**

⚠️ **NEVER** install Child Restraint without Base using a non-locking vehicle belt. The installation will NOT be secure. Refer to your vehicle owner's manual for detailed vehicle belt information.

1



See page 16 for "Vehicle Seating Positions" before installing. Make sure the vehicle is on a level surface. Place Child Restraint on selected vehicle seat with child properly secured in Child Restraint (See *securing your child* on page 64). Make sure it is not blocking the vehicle seat belt buckle.

2

Position Child Restraint so that the Level Line (located on the seat label) is **LEVEL** with the ground.

3

If needed, use a rolled up towel to help level the Child Restraint properly.

**Installation Options:**

- *Lap-Shoulder Belt installation continued on page 52.*
- *Lap Belt Only installation continued on page 56.*

## INSTALL **WITHOUT** BASE SETUP

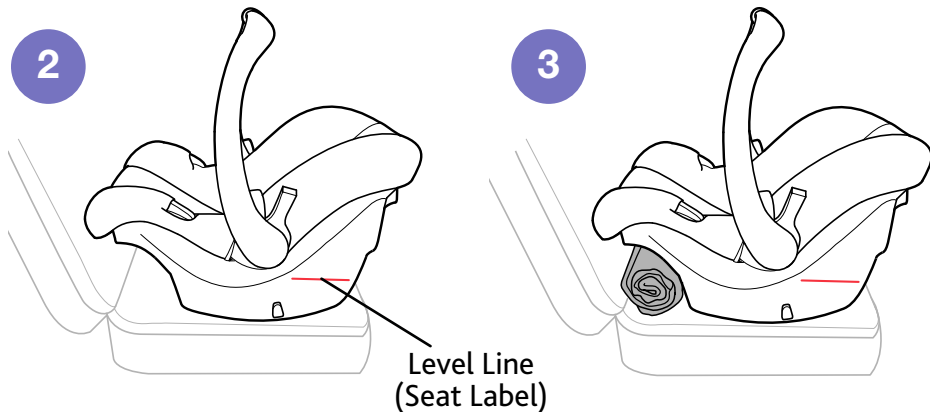

**⚠ ALWAYS** place handle in LOCKED "CARRY" position when using infant restraint system in vehicle.

## INSTALL USING LAP-SHOULDER BELT

- 1 Thread vehicle seat belt up and slide into the Seat Belt Guide on the side of the Child Restraint.
- 2 Pull vehicle seat belt down and slide into the Seat Belt Guide on opposite side of the Child Restraint. Buckle the vehicle seat belt. Pull out all of the shoulder belt webbing and activate the locking mode of the vehicle belt. If belt does not lock, do not use that seating position to install the carrier.

## INSTALL USING LAP-SHOULDER BELT

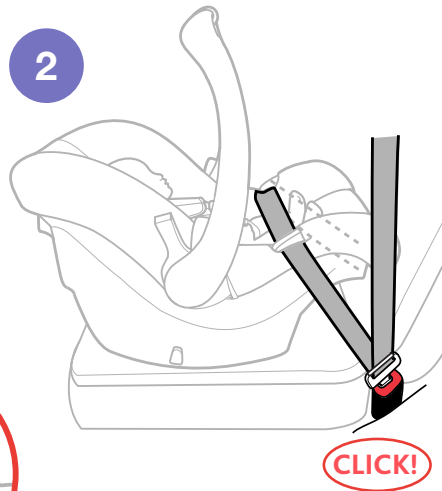
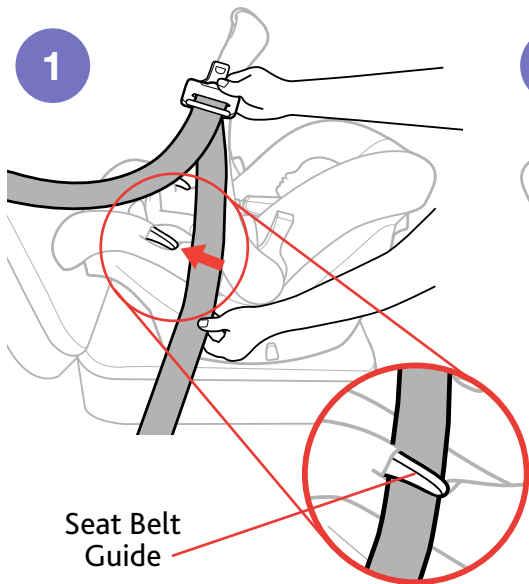

## INSTALL USING LAP-SHOULDER BELT

*Put the vehicle seat belt in the locked mode, see vehicle owner's manual for more information. A tightly rolled towel may be used under the front edge of the Carrier if needed to adjust the angle of the Carrier. Angle is correct when level line on Carrier is level with ground.*

3

While pushing down on the Carrier, pull up on the vehicle shoulder belt to remove all slack from vehicle lap belt.

## CHECK YOUR WORK

- ✓ Hold Child Restraint at each side and pull side to side and forward. Child Restraint should not move more than 25 mm (1 inch) from vehicle seat back or side-to-side.
- ✓ Make sure Child Restraint is level. Make sure infant's head does not fall forward. If necessary re-adjust recline and repeat installation steps to make sure Child Restraint is installed properly.
- ✓ Check installation before every use!



## INSTALL USING LAP-SHOULDER BELT

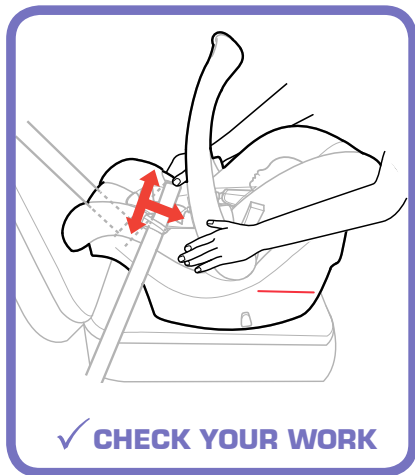
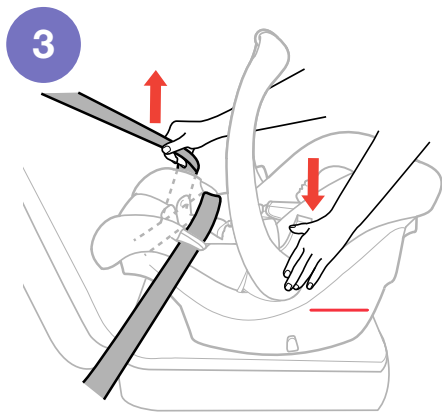

⚠ **ALWAYS** place handle in LOCKED "CARRY" position when using infant restraint system in vehicle.

## INSTALL USING LAP BELT ONLY

- 1 Thread vehicle seat belt up and slide into the Seat Belt Guide on the side of the Child Restraint.
- 2 Pull vehicle seat belt down and slide into the Seat Belt Guide on opposite side of the Child Restraint. Buckle the vehicle seat belt.

## INSTALL USING LAP BELT ONLY

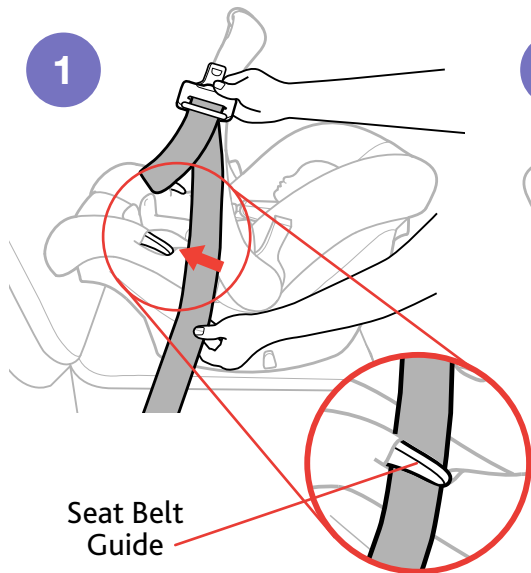

## INSTALL USING LAP BELT ONLY

*Put the vehicle seat belt in the locked mode, see vehicle owner's manual for more information. A tightly rolled towel may be used under the front edge of the Carrier if needed to adjust the angle of the Carrier. Angle is correct when level line on Carrier is level with ground.*

3

While pushing down on the Child Restraint, pull up on the loose end of the vehicle lap belt to remove all slack.

## CHECK YOUR WORK

- ✓ Hold Child Restraint at each side and pull side to side and forward. Child Restraint should not move more than 25 mm (1 inch) from vehicle seat back or side-to-side.
- ✓ Make sure Child Restraint is level. Make sure infant's head does not fall forward. If necessary re-adjust recline and repeat installation steps to make sure Child Restraint is installed properly.
- ✓ Check installation before every use!

## INSTALL USING LAP BELT ONLY

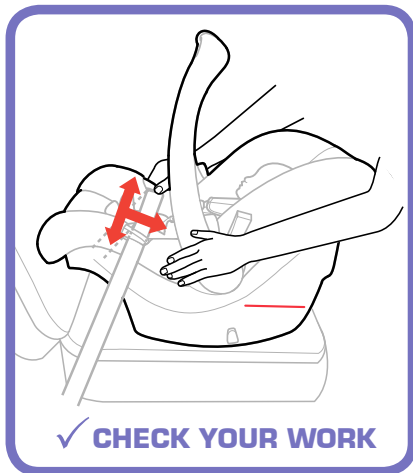
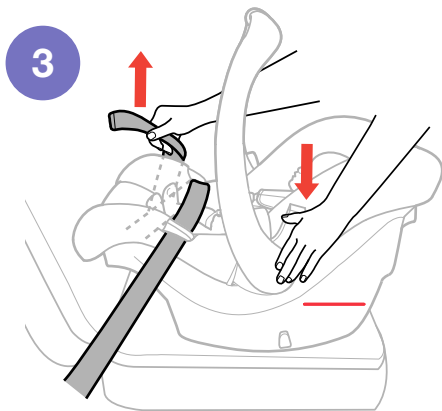

**▲ ALWAYS** place handle in LOCKED "CARRY" position when using infant restraint system in vehicle.

## ADJUSTING HARNESS HEIGHT

- 1 With child seated correctly in the Carrier, resting against back and bottom of carrier and not slouched, locate the Harness Strap Adjustment Slot closest to AT or JUST BELOW top of child's shoulders.
- 2 Remove your child from the carrier and loosen the Harness Straps. Turn the Carrier over and locate the splitter plate. Unhook one Harness Strap from the Splitter Plate.

## ADJUSTING HARNESS HEIGHT

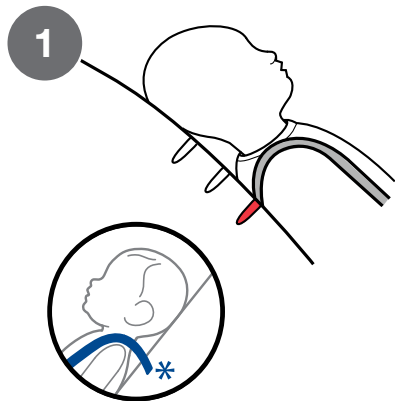

**AT OR JUST BELOW**

Splitter  
Plate

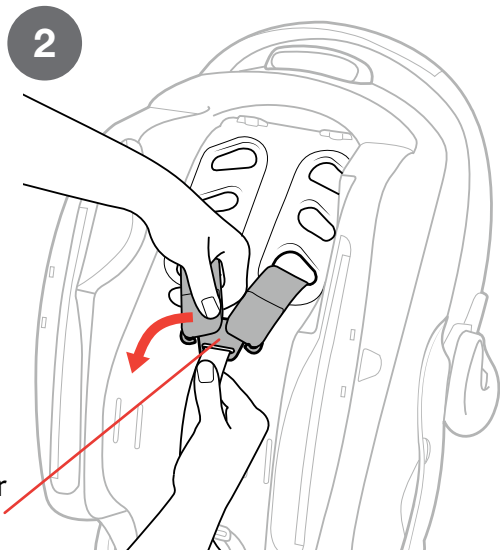

## ADJUSTING HARNESS HEIGHT

- 3 Pull Harness Strap out through the front of the Carrier. Then re-thread the Harness Strap through the desired Harness Strap Adjustment Slot.
- 4 Re-attach Harness Strap to the Splitter Plate. Repeat steps 1-4 of Adjusting Harness Height for the other Harness Strap. Make sure both Harness Straps are at positioned at the same height, as shown.

**▲ WARNING** - Make sure Harness Straps are **NOT** twisted and both Harness Straps are securely attached to the Splitter Plate.



## ADJUSTING HARNESS HEIGHT



## SECURING CHILD WITH HARNESS

*For a better fit in the Carrier with smaller infants, the provided Newborn Positioner may be needed. See page 76 for more details.*

- 1 Loosen harness by pressing the Adjuster Button and pulling out on both Harness Straps.
- 2 Press the button on the buckle and release both buckle tongues.
- 3 Separate chest clip and spread Harness Straps apart. Place child in carrier in seated position.

*Child must be resting against back and bottom of carrier. Make sure child is not slouched.*

## SECURING CHILD WITH HARNESS

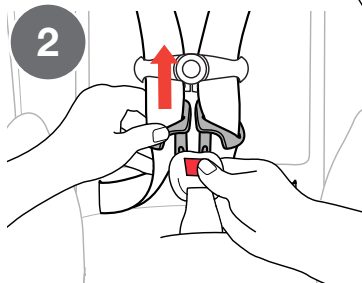
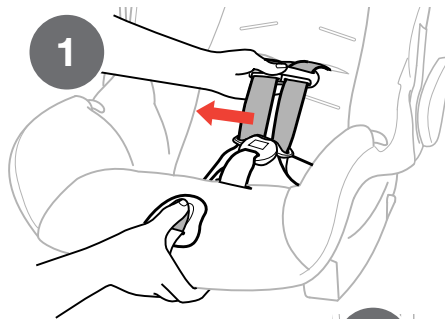

## SECURING CHILD WITH HARNESS

- 4 Make sure harness straps are AT or JUST BELOW top of child's shoulders. If not, refer to page 60 for Adjusting Harness Height.

**⚠ NEVER** use clothing or blankets that interfere with fastening or tightening the harness. An unsecured child could be ejected in a sharp turn, sudden stop or crash!

- 5 Pull Harness Straps over child's shoulders and pull waist straps around their waist.

*Never secure child in Carrier with child dressed in bulky garments or heavy clothing. Heavy clothing can prevent harness from being properly tightened around child.*

## SECURING CHILD WITH HARNESS

4

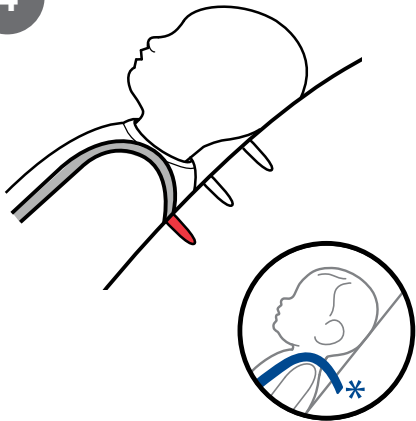

**AT OR JUST BELOW**

5

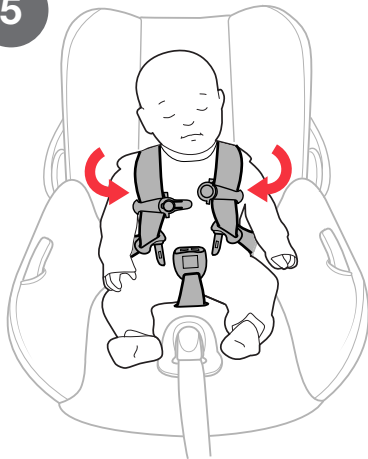

## SECURING CHILD WITH HARNESS

- 6 Insert each Buckle Tongue into Harness Buckle; listen for a click **(6a)**. Pull up firmly on both Buckle Tongues to make sure that they are securely latched **(6b)**.
- 7 Fasten Chest Clip by snapping both sides together.

*Harness Straps must be laying flat, free of twists and on top of child's shoulders.*

## SECURING CHILD WITH HARNESS

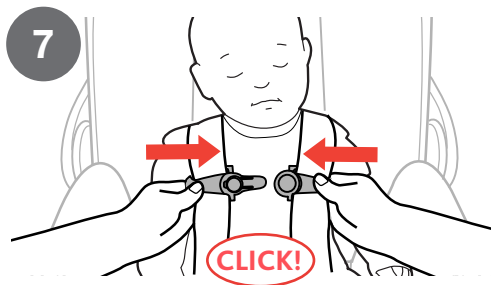
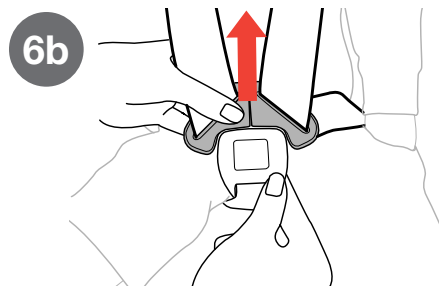
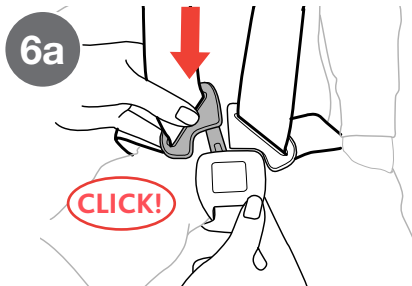

## SECURING CHILD WITH HARNESS

*Pull excess strap up through buckle tongues so that harness is snug around child's thighs.*

- 8 Tighten the harness by pulling slowly on Harness Adjuster Strap while pulling up on both shoulder straps to remove all slack from below **(8a)**. Make sure the Harness Straps are snug on child. If you can pinch a fold in the Harness Strap at the child's shoulders, harness is too loose **(8b)**. If the Harness Straps are too loose pull the Harness Adjuster Strap more.
- 9 Move the Shoulder Pads up to the child's shoulders. Slide Chest Clip up to center of child's chest, level with the armpits.

**⚠ WARNING** - If harness is not snug around your child, child could be ejected in a sharp turn, sudden stop or crash resulting in serious injury or death.



## SECURING CHILD WITH HARNESS

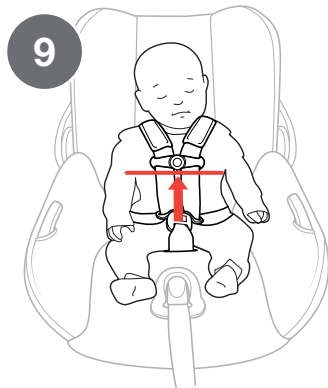
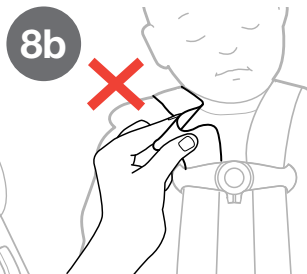
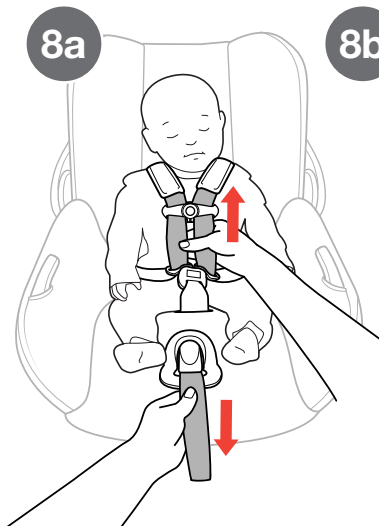

## SECURING CHILD CHECKLIST

- ✓ **Harness Straps must be snug.** If you can pinch a fold in the strap at the shoulders, the harness is too loose. A snug strap should not allow any slack. It lies in a relatively straight line without sagging. It does not press on the child's flesh or push the child's body into an unnatural position.

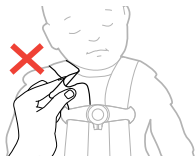

- ✓ **To ensure a better fit for smaller infants, the Newborn Positioner may be needed.** Never place extra padding under or behind the child. Only use the Newborn Positioner. Never use Newborn Positioner if child weighs more than 5 kg (11 lbs).
- ✓ **Straps must lay flat, free of twists and centered on top of the child's shoulders.**
- ✓ **Check the height of the Harness Straps: Position the Harness Straps at or just below the child's shoulders.**



## SECURING CHILD CHECKLIST

- ✓ Check the position of Chest Clip: Chest Clip should be centered on the child's chest, level with the armpits.
- ✓ Never secure child in Carrier with child dressed in bulky garments or heavy clothing. Heavy clothing can prevent harness from being properly tightened around child.
- ✓ Never secure child in Carrier with child wrapped in a blanket. To keep child warm, place a blanket over child AFTER you have properly secured and tightened harness around child.



NO Bulky Clothing

## BASE RELEASE HANDLE

### RELEASE CARRIER FROM BASE:

To unhook the Carrier from the Base, squeeze the Base Release Handle on the back of the Carrier then lift up on the Carry Handle.

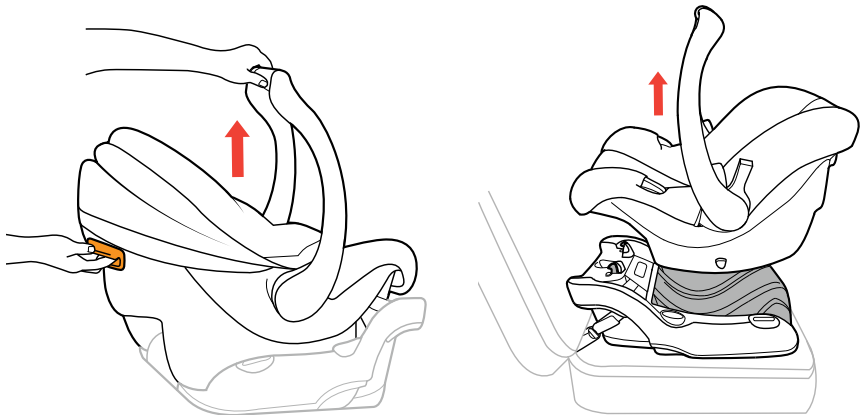

## UAS STORAGE

▲ Store UAS Connectors properly in the compartments when not using for installation.

Store both UAS Connector in compartments on either side of the Base when not in use.

- 1 Insert UAS Connectors into the UAS Connector storage compartments.
- 2 Pull on the UAS Pull Strap to secure UAS Connectors in the compartments.
- 3 Roll UAS Pull Strap and store in Pull Strap Storage Slot.

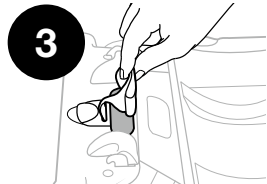
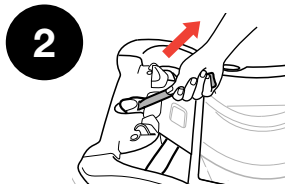
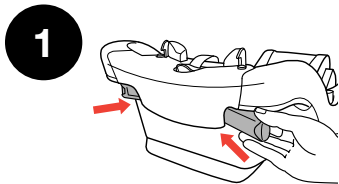

## NEWBORN POSITIONER

**⚠ WARNING** - Use the NEWBORN POSITIONER provided for infants who weigh between 1.8 and 5 kg (4 and 11 lbs).

To ensure a better fit for smaller infants the Newborn Positioner may be needed. Do NOT use any other newborn positioner or pillows. Only use the one provided by Chicco for this Child Restraint.

- 1** Place the Newborn Positioner in the Carrier seat. Then pull the Buckle through slot in the bottom of Newborn Positioner.
- 2** Pull both Harness Straps over the side panels of Newborn Positioner.
- 3** Push Newborn Positioner firmly into Carrier to make sure it is properly positioned against the back of the seating area.

## NEWBORN POSITIONER

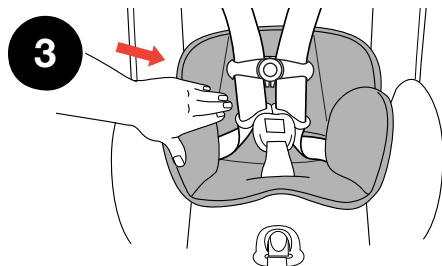
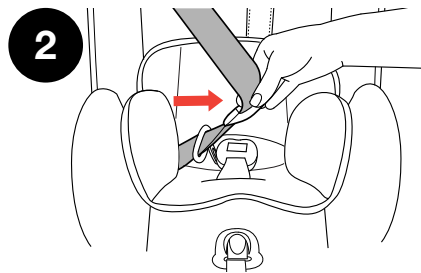
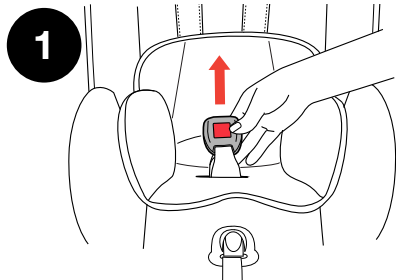

## HEAD REST INSERT

To provide head support for smaller infants the Head Rest Insert may be used. The Head Rest Insert can be used with or without the Newborn Positioner.

- 1 To Install Head Rest Insert, thread the Head Rest Straps through the Harness Strap Adjustment Slots on the seat back.
- 2 Attach Head Rest hook and loop straps together.

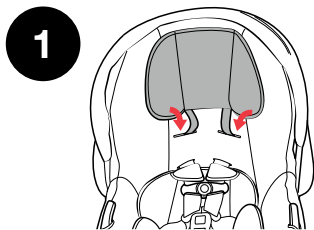

**▲ NEVER** use Head Rest Insert with harness in upper slots. Head Rest Insert could interfere with harness adjustment.



## HANDLE POSITIONS

To Adjust the Handle, press both of the Handle Release Buttons and rotate the handle. There are 3 positions:

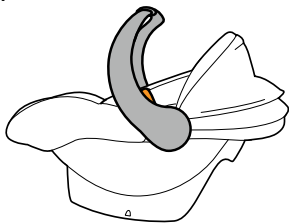

Carrying Position

**⚠ ALWAYS** place handle in LOCKED "CARRY" position when using infant restraint system in vehicle.

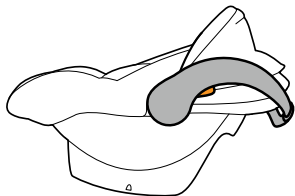

Rocking Position

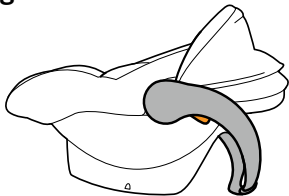

Stationary Position

**⚠ BE SURE** handle is LOCKED in "CARRY" position before lifting Carrier by handle. An unlocked handle could move unexpectedly, causing injury to infant.

## CANOPY

### ADJUSTING CANOPY:

The Canopy can be adjusted by rotating the canopy forwards or backwards.

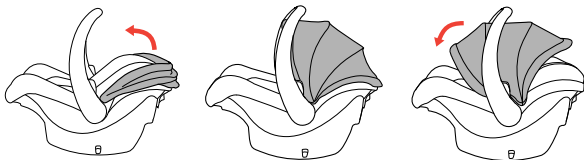

### REMOVING CANOPY:

- 1** Pull back the fabric and press the button on Canopy Mount and pull up to remove. Repeat for the other side.

### ATTACHING CANOPY:

- 2** Re-attach both of the Canopy Mounts into the slots on the side of the Carrier.

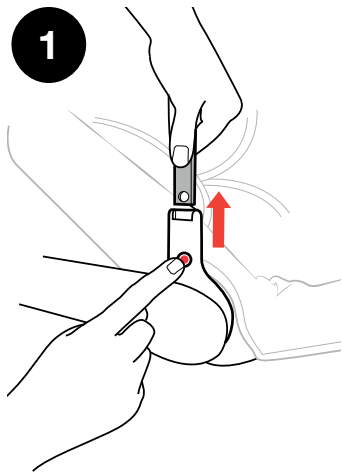

## INSTALLATION ON AN AIRCRAFT

*When traveling by airplane with your child, Chicco recommends taking the Carrier on the airplane with you so that you can use it with your child. Not only will it protect your child during take-off, landing, and turbulence, but also allow your child to be more comfortable.*

- This Child Restraint is certified for use on aircraft. Contact the airline prior to travel to discuss their Child Restraint policy.
- Use this Child Restraint only on FORWARD-FACING aircraft seats.
- Install Carrier on an aircraft the same way it is installed in a vehicle when using a vehicle lap belt. Reference Without Base Installation Lap Belt ONLY on page 56.

**⚠ Cannot be used with base in an aircraft.**

## CLEANING AND MAINTENANCE

**⚠ DO NOT USE BLEACH**, solvents or household cleaners as they may weaken plastics and straps.

**⚠ DO NOT USE SOAPS OR LUBRICANTS** on Buckle or UAS hardware. It may cause them to malfunction.

- **Fabrics may be spot-cleaned, hand or machine washed:**

Hand wash using mild soap and water, or machine washed in cold water on delicate cycle using mild detergent. Hang to dry.

**⚠ NEVER** use Child Restraint without the seat pad.

*For softgood removal instructions visit the Chicco website at [www.chicco.ca](http://www.chicco.ca) or call 1-800-667-8184.*

- **Cleaning Shoulder Pads:**

Hand wash using mild soap and water. Hang to dry.

- **Cleaning Plastics:**

Sponge clean using warm water and mild soap. Towel dry.

## CLEANING AND MAINTENANCE

- **Cleaning Harness:**

Sponge clean using warm water and mild soap. Air dry. **Do NOT machine wash.**

**▲ DO NOT USE** Child Restraint if any part of the harness is damaged. For proper removal and installation of the harness straps visit the Chicco website at [www.chicco.ca](http://www.chicco.ca) or call 1-800-667-8184.

- **Cleaning UAS Straps:**

UAS Straps cannot be replaced.

Sponge clean using warm water and mild soap. Air dry.

- **Cleaning Buckle and UAS Hardware:**

Sponge clean, using warm water. If debris in buckle, remove and rinse in warm cup of water. Air dry.



Do **NOT** remove UAS or Harness Adjuster Straps. For additional information visit the Chicco website at [www.chicco.ca](http://www.chicco.ca) or call 1-800-667-8184.

